

# Assembly Instructions (B)

01

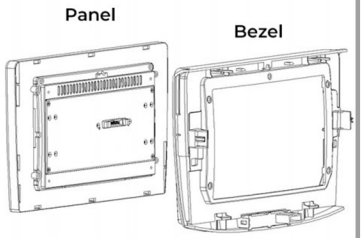

02

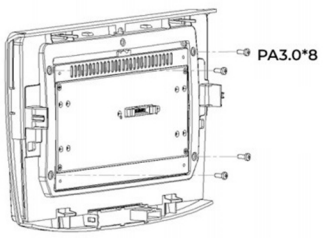

Attach the bezel on the panel with screws

03

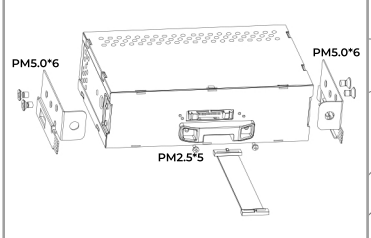

Attach the plastic bracket and metal bracket on the headunit with screws

04

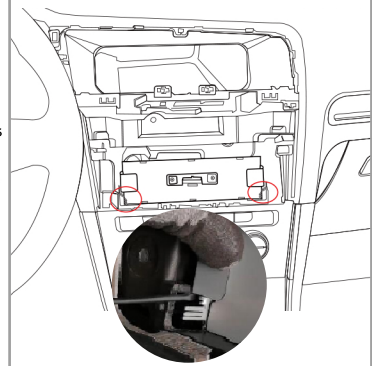

Bend the tabs of the left and right metal brackets with a flathead screwdriver

05

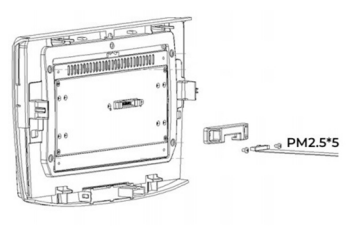

Attach the plastic bracket on the panel with screws

06

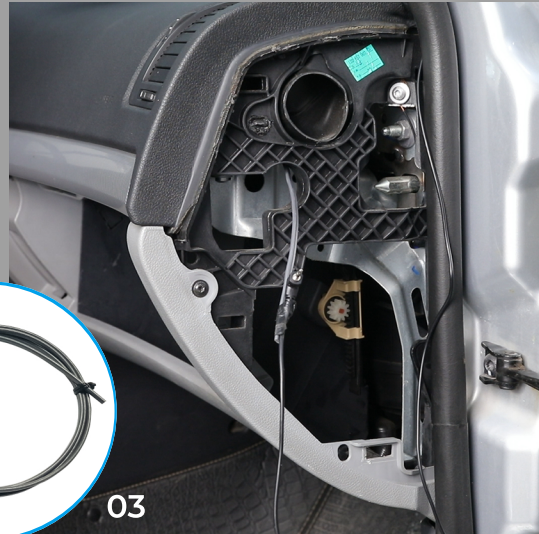
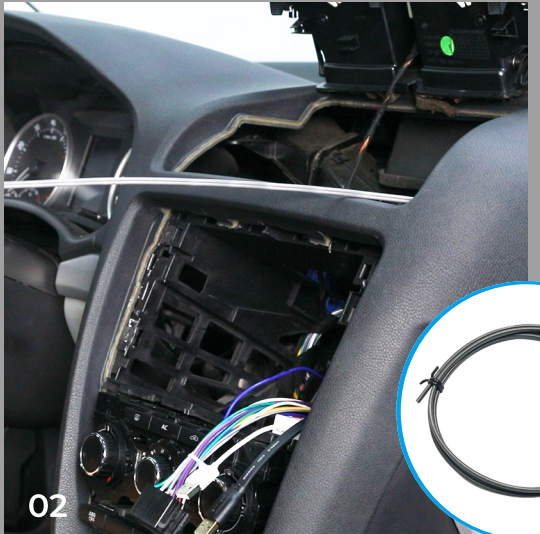
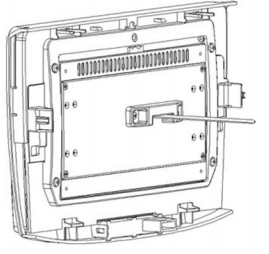

How to use fish tape?



# EINBAUANLEITUNG **(B)**

01

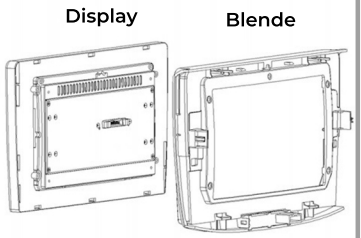

02

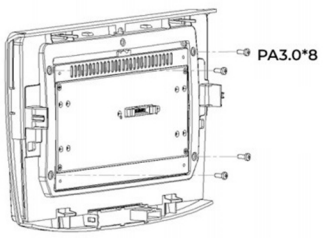

Befestigen Sie die blende mit Schrauben an das Display

03

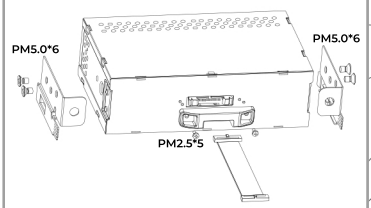

Befestigen Sie die Kunststoffhalterung und Metallbügel mit Schrauben an das Radio

04

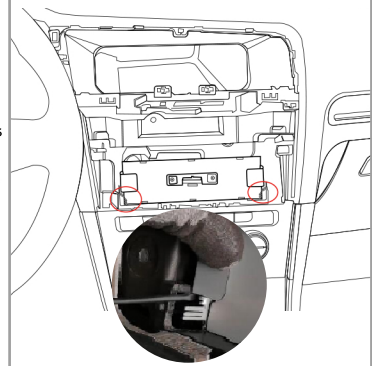

Biegen Sie die Laschen der linken und rechten Metallhalterung mit einem Schlitzschraubendreher

05

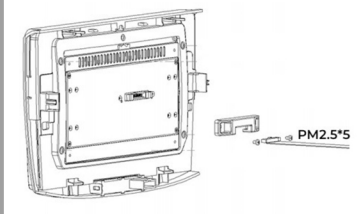

Befestigen Sie die Kunststoffhalterung mit Schrauben an das Display

06

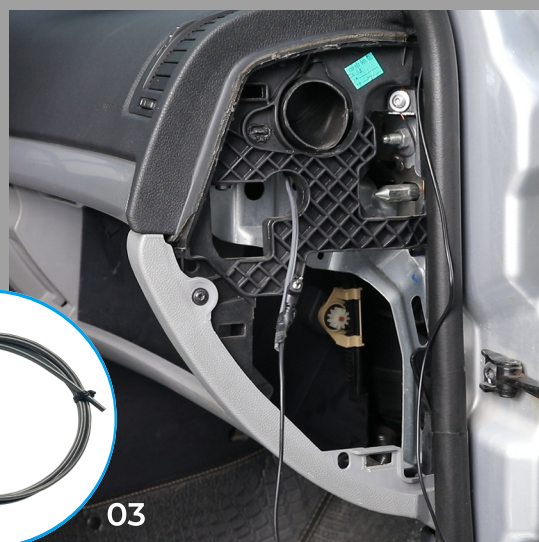
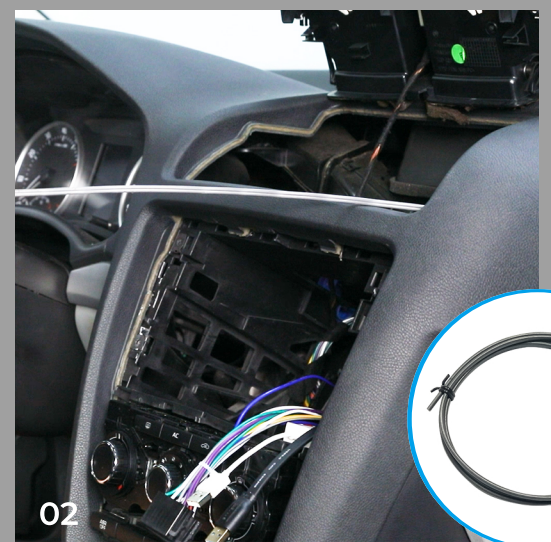
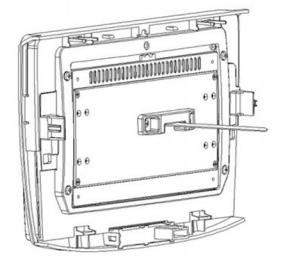

Wofür ist die Kabel-Durchziehhilfe?