

Assembly Instructions (B)

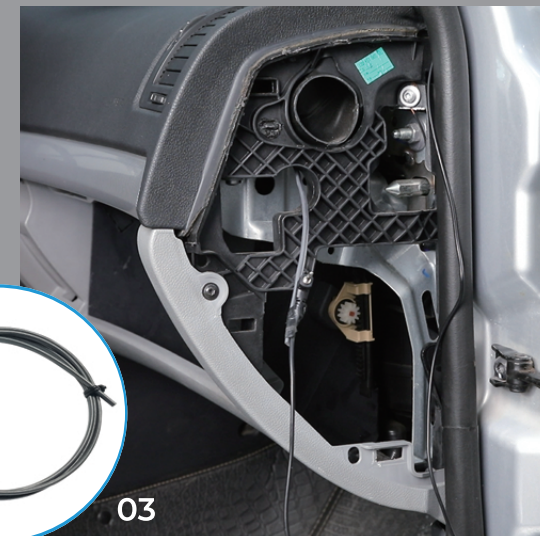
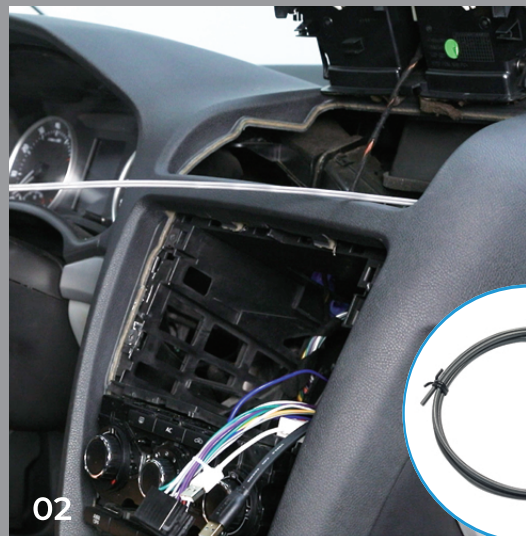
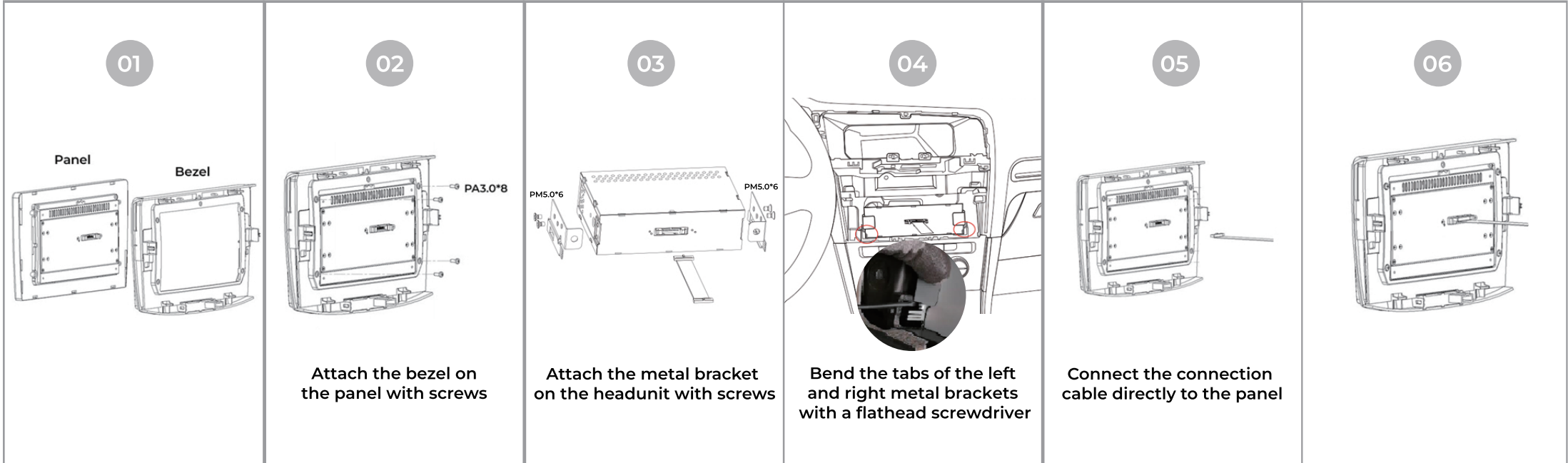

How to use fish tape?

EINBAUANLEITUNG (B)

01

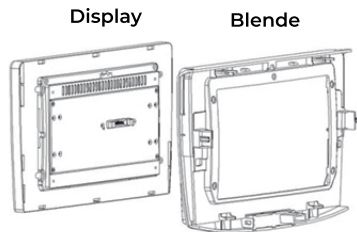

02

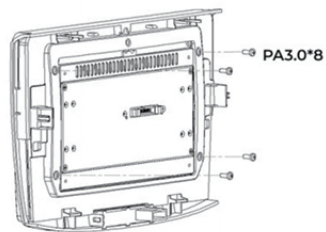

Befestigen Sie die blende mit Schrauben an das Display

03

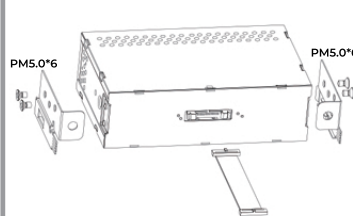

Befestigen Sie die Metallbügel mit Schrauben an das Radio

04

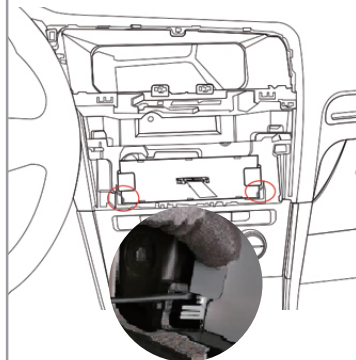

Biegen Sie die Laschen der linken und rechten Metallhalterung mit einem Schlitzschraubendreher

05

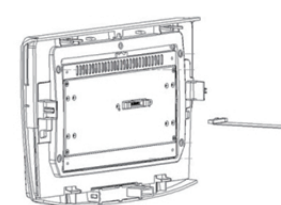

Verbinden Sie das Anschlusskabel direkt mit dem Panel

06

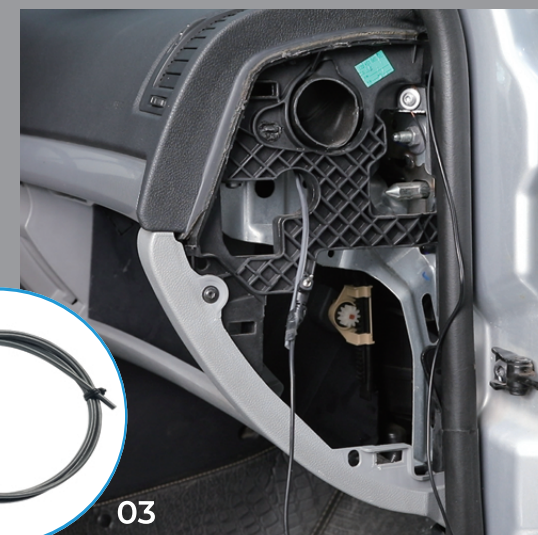
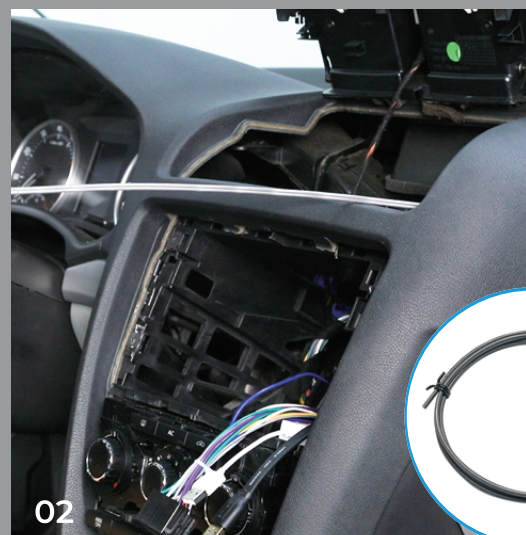
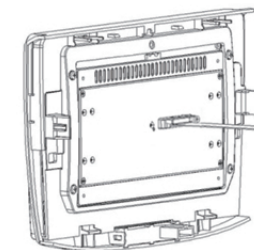

Wofür ist die Kabel-Durchziehhilfe?